



Turbinator

Foam Mixing Technology



WE KNOW FIRE
WE KNOW SAFETY
WE KNOW YOU



THE TURBINATOR

WATER DRIVEN FOAM PROPORTIONER

The Turbinator is designed to accurately mix foam concentrate liquid with either freshwater or seawater and is suitable for use in fixed systems or in mobile units for portable use. The Turbinator is available in a range of sizes and comprises of two main parts; a water powered motor and a foam concentrate pump.

The motor and pump are close coupled and integrated within a single compact body and both are 'positive displacement' rotary devices. Consequently for every revolution of the water motor a fixed volume of water passes through the machine, and similarly for every revolution of the foam pump a fixed volume of concentrate is delivered. In this way the required water to foam mixing ratio is obtained regardless of operating pressure.

The unique design of the Turbinator makes the device inherently self priming. The gear type foam pump develops a strong inlet suction leading to a reliable and uninterrupted foam concentrate supply.



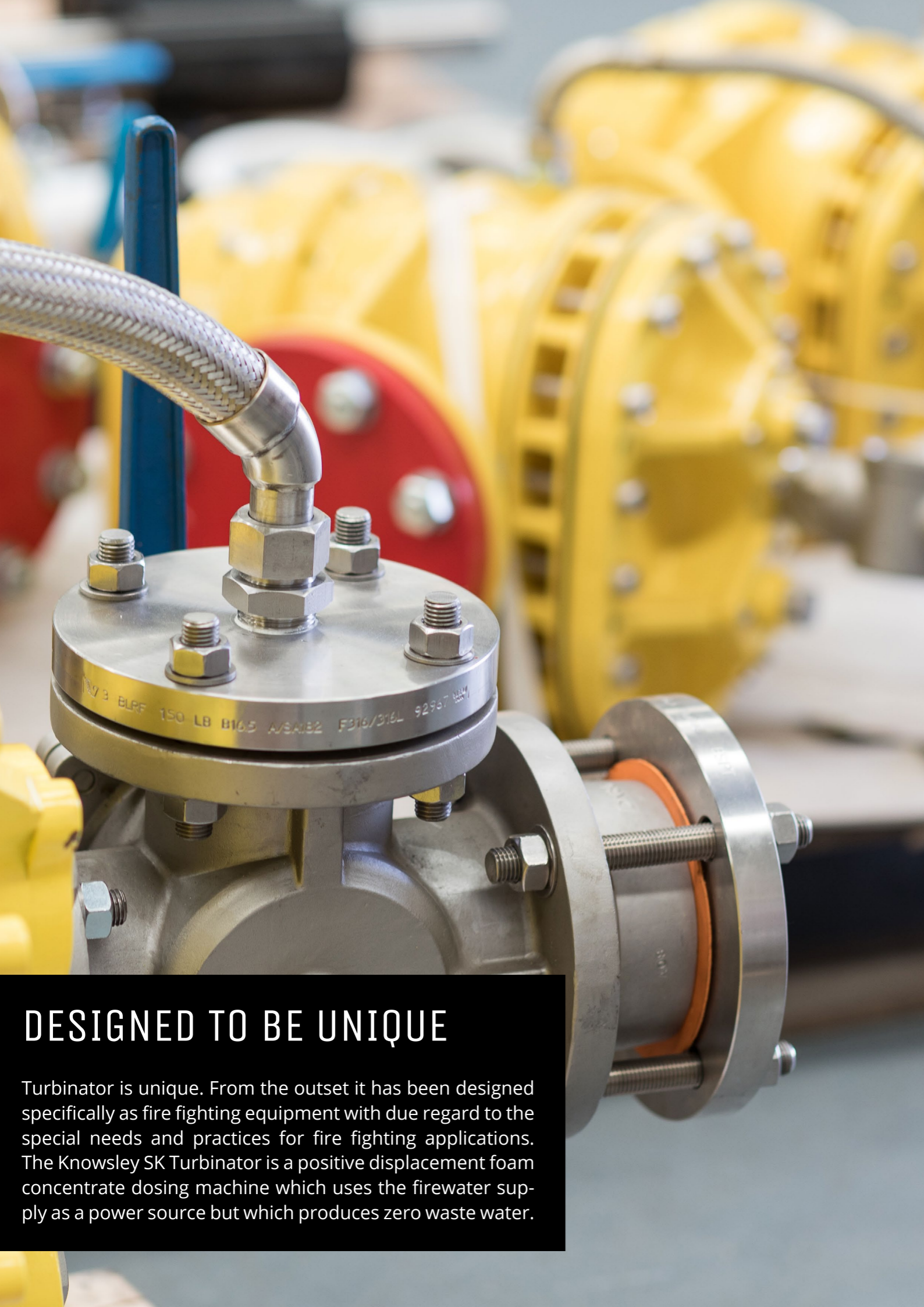

COMPACT AND SIMPLE

The Turbinator is very compact enabling it to be easily installed into new systems or retrofitted into existing foam systems. There are no complicated installation requirements.



DRY RUNNING TO NFPA20

NFPA 20 states that all stationary foam pumps must be capable of dry running for at least ten minutes. Compliance is critical for all listed systems.

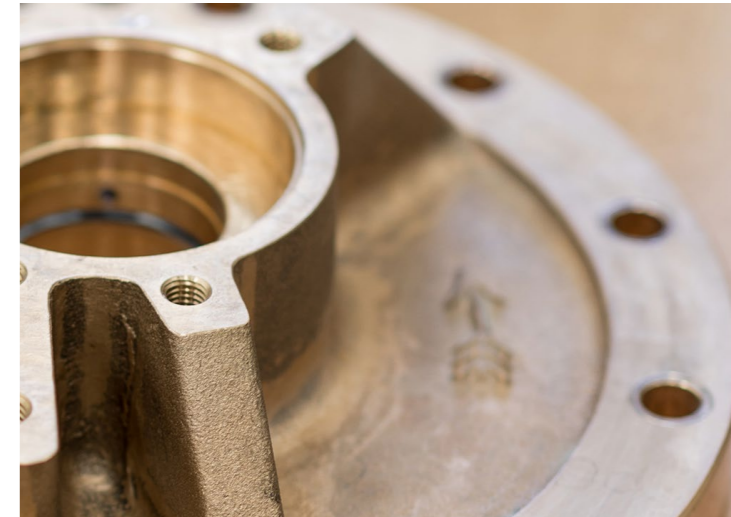

TROUBLEFREE START-UP

Turbinator has a very high suction lift capability and tolerance to air in the suction piping so no complicated priming procedures are required on start-up.

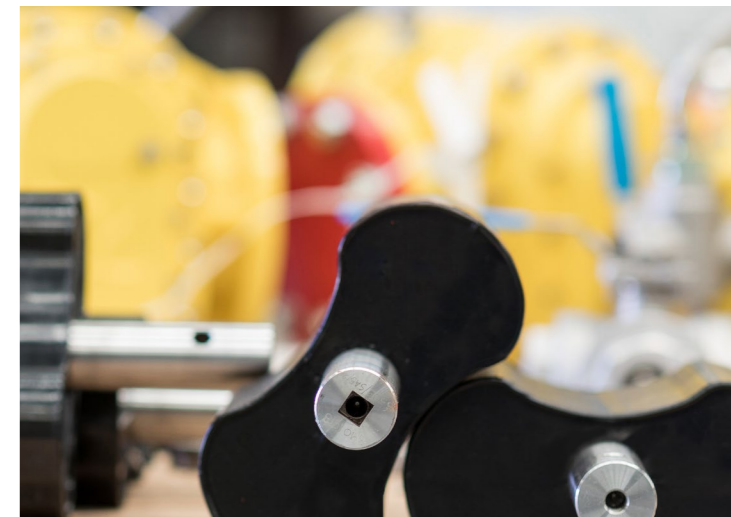

DESIGNED TO BE UNIQUE

Turbinator is unique. From the outset it has been designed specifically as fire fighting equipment with due regard to the special needs and practices for fire fighting applications. The Knowsley SK Turbinator is a positive displacement foam concentrate dosing machine which uses the firewater supply as a power source but which produces zero waste water.

CONFIGURATIONS



FIXED SYSTEMS

The Turbinator has the flexibility to be integrated into any type of fixed foam system, whether for tank storage areas, process plant areas of oil & gas plant or for offshore systems such as helideck monitors or DIFFS or integrated into general area foam deluge systems.



MOBILE SYSTEMS

The compact design of the Turbinator makes it ideal for integration into mobile equipment including hand portable trolley units, towable road trailers or integration into fire trucks. Standard packages are available to suit most common applications or we can individually design to suit specific requirements.

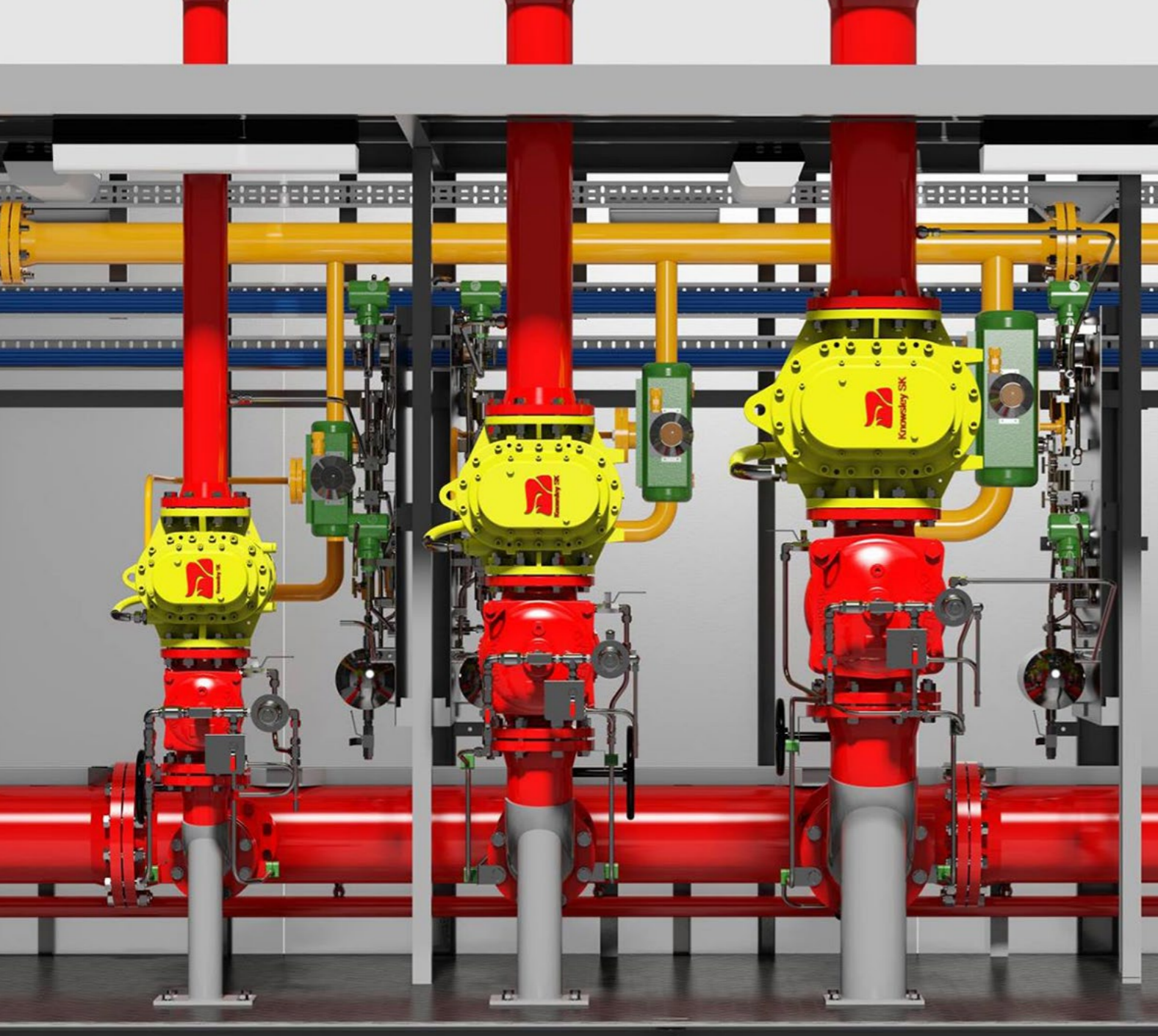

KEY FEATURES

- + Can be used in hazardous areas
- + Compact
- + No external power source required
- + Easy to use - no special start-up procedures
- + Low pressure drop
- + Variable flow
- + Highly tolerant to overspeed
- + Can be installed in vertical or horizontal pipes

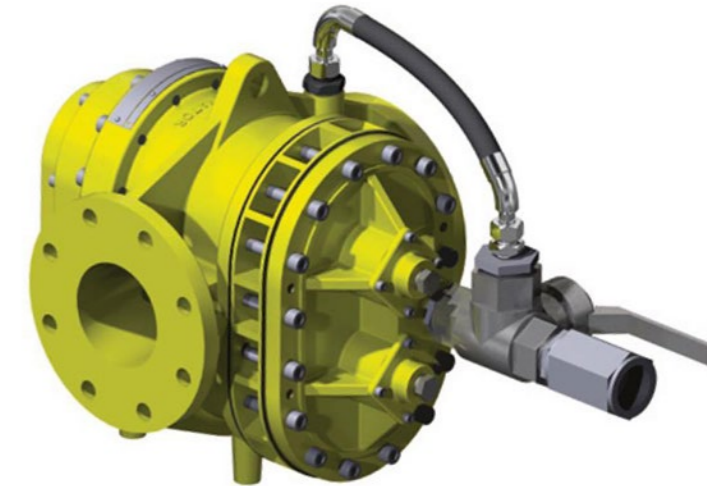

DESIGNED FOR

- + Low maintenance
- + Fresh water and sea water versions
- + Proportioning over a wide flow
- + Available in 1% and 3% proportioning rates
- + Resistant to debris in firewater
- + CE marked
- + NFPA compliant for dry running
- + Low noise emissions

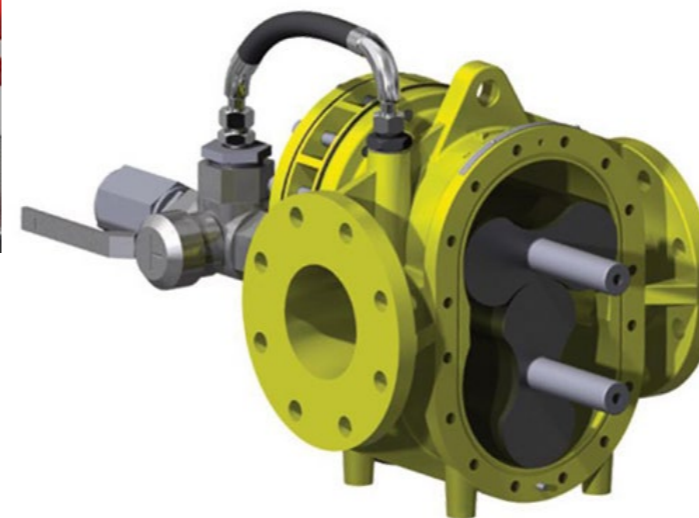

MATERIALS OF CONSTRUCTION

STANDARD

Body	Gunmetal BS 1400 LG2
Rotors	Nitrile coated Stainless Steel 431
Gears	Acetal
Gear housing	Gunmetal BS 1400 LG2
Mechanical seals	Stainless steel / rubber
Fasteners	Stainless steel 316

OFFSHORE

Gunmetal BS 1400 LG2
Nitrile coated Super Duplex F55
Acetal
Gunmetal BS 1400 LG2
Hastelloy / rubber
Stainless steel 316

FOR THE EUROPEAN MARKET, THE PRODUCTS WILL BE CE MARKED UNDER THE MACHINERY DIRECTIVE 2006/42/EC AND UNDER THE ATEX DIRECTIVE 94/9/EC.

RANGE & PERFORMANCE

	MIDI	MIDI-PLUS	MAXI
Nominal size	4"	6"	8"
Flow range (l/min)	500 - 3000	1000 - 6500	1500 - 12000
Water connection	4" ANSI 150# Flange or DIN PN16	6" ANSI 150# Flange or DIN PN16	8" ANSI 150# Flange or DIN PN16
Foam connection	1.1/2"BSP	2"ANSI 150# or 2"BSP	2.1/2"BSP or 3"ANSI 150#
Dimensions (mm)			
A	669	742	936
B	350	400	500
C	418	515	645
D	150	200	250
E	150	200	270
Foot holes	M10	M12	M16
Weight (kg)	130	204	400

Temperature range 2°C to 50°C

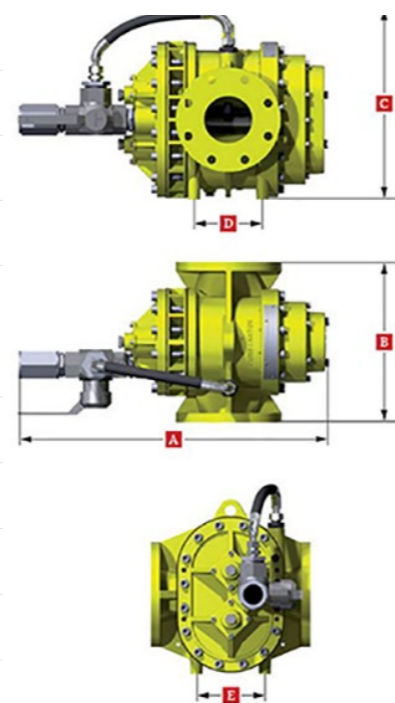

PRESSURE LOSS

One of the lowest pressure drop for a water driven foam proportioner in the market. Contact us for a detailed overview of Fluid Flow and Pressure Loss specifications.

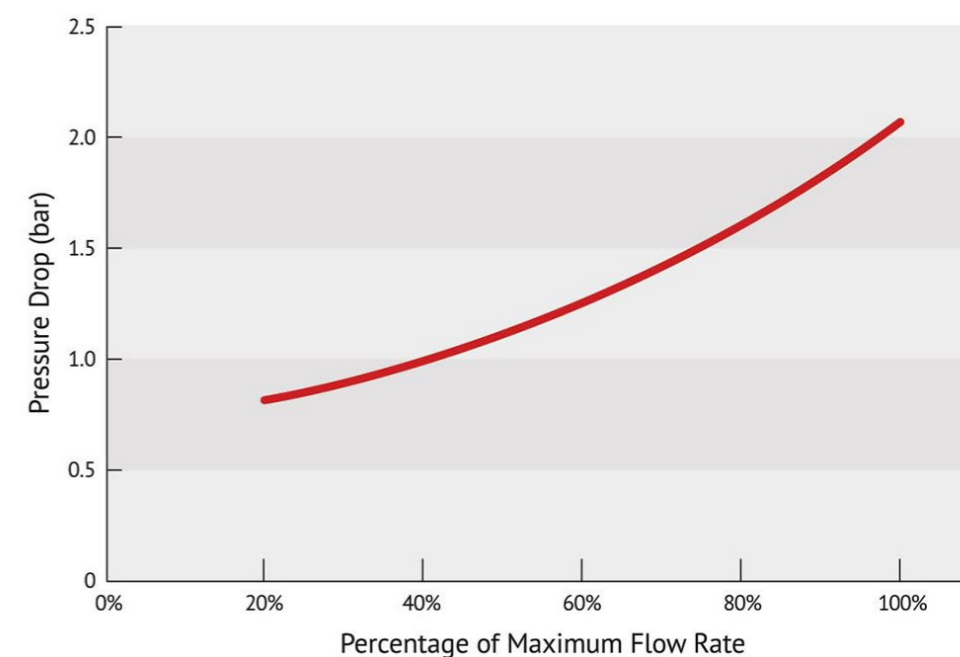

TURBINATOR IS MANUFACTURED FROM THE HIGHEST GRADE MATERIAL SELECTIONS TO ENSURE CORROSION RESISTANCE IN THE HARSHTEST OF ENVIRONMENTS



TECHNOLOGY BUILT TO LAST

With Turbinator we have introduced a flexible, abrasion resistant paddle material in the water motor which gives the unit its unique wear characteristics. The usual contamination found in firewater networks does not damage the paddles as the water motor was designed using two lobe paddles which allow any potential contaminants or debris to pass through the unit without causing blockage. Over speeding up to 120% which can occur during automatic activation in large dry systems does not damage the unit due to the robust design. In addition and most importantly the Turbinator meets NFPA20 requirements for dry running.



HOW IT WORKS

Standard packages are available to suit most common applications or we can individually design to suit specific requirements.

Turbinator does not require external power supplies or control circuits and is safe for installation in any ATEX environment – provided firewater pressure is available then the foam system will be ready for use.

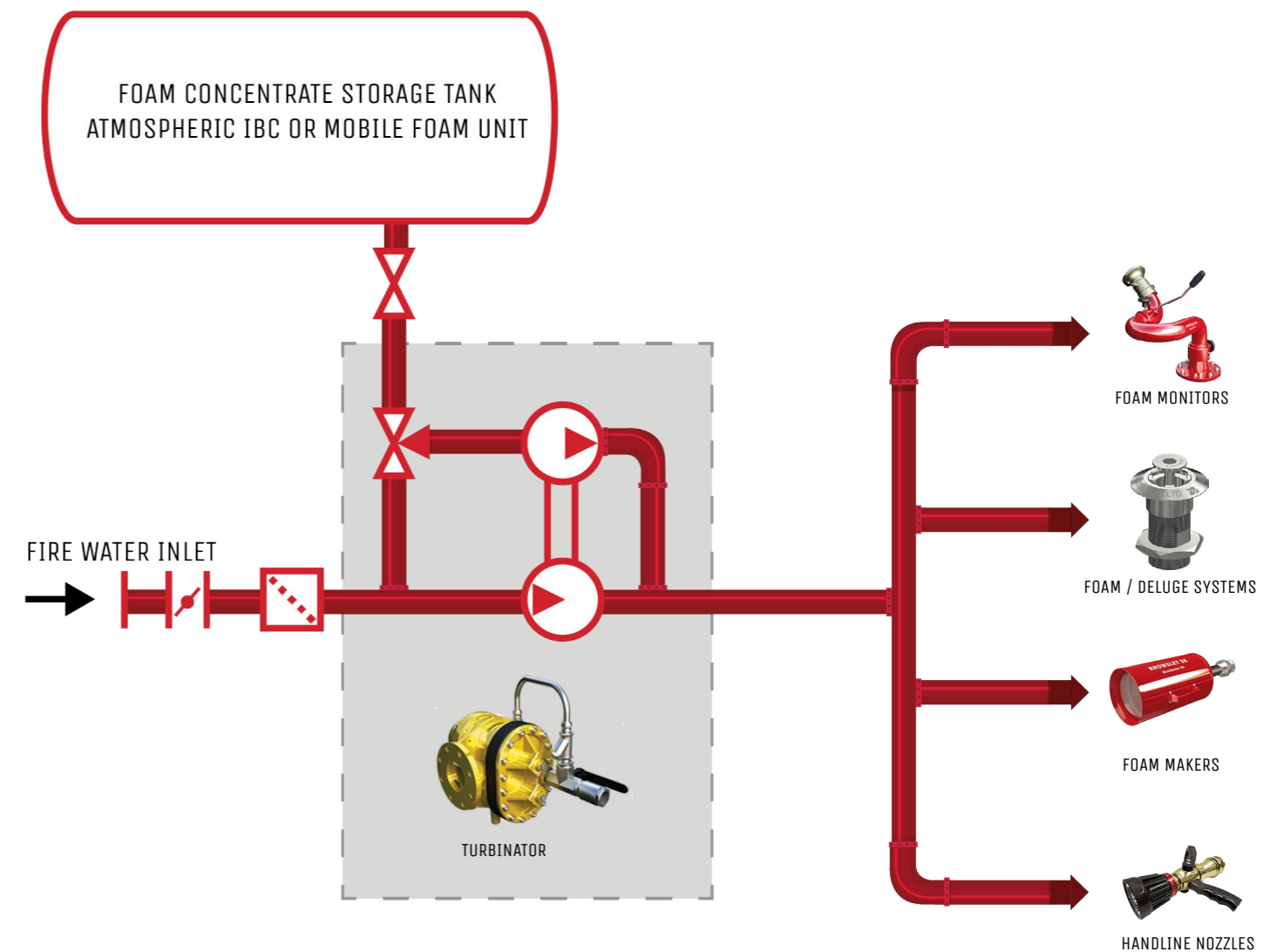

P&ID of a typical Turbinator installation

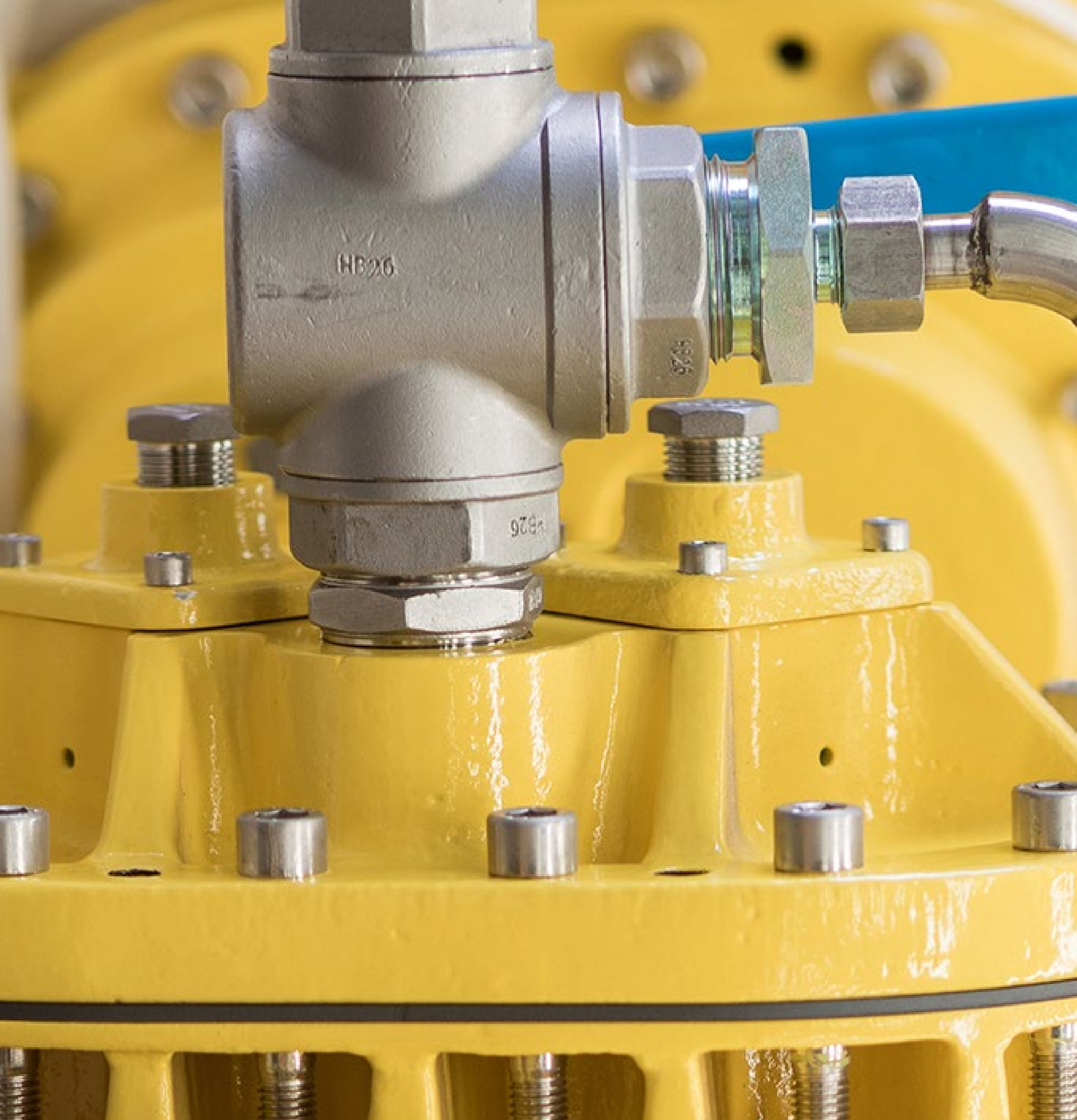

QUALITY CONTROL

BATCH TESTING AND SAMPLING

To ensure the correct processing of the selected high grade materials, we maintain strict standards on batch testing and sampling, and batch traceability. Together with our subsuppliers we developed vigorous testing schemes for each relevant part and for each specific material.

Our highly qualified QA specialists not only understand the Knowsley products, but – equally important – also understand our customers requirements.

You can rest assured that all our products are built in line with the processes and procedures that we have laid out as part of our QMS system that complies fully with ISO 9001 – 2015.

OUR UNIQUE TEST RIG

Each Turbinator is subjected to a rigorous series of tests before leaving the factory. We have invested in a dedicated test rig that's capable of testing each model of Turbinator over its full range of operating flows and pressures. All test data is collected and registered in an automated, standardised method. The test data for every unit is stored in our project files and forms part of a comprehensive report delivered with each Turbinator.



ESTABLISHED IN 1896

KNOWSLEY SK LTD. HAS AN ENVIABLE REPUTATION FOR MANUFACTURING QUALITY FIRE FIGHTING EQUIPMENT AND SYSTEMS FOR HIGH VALUE ASSET PROTECTION THAT CAN BE RELIED UPON WHEN DANGER STRIKES.

KNOWSLEY SK

Centrepint
Marshall Stevens Way
Trafford Park
Manchester M17 1AE
United Kingdom

T: +44 (0) 161 872 7511

F: +44 (0) 161 848 8508

E: sales@knowsleysk.co.uk

KNOWSLEY SK MIDDLE EAST

Plot No. 2, Sector M 15
PO Box 6203
Mussafah
Abu Dhabi
United Arab Emirates

WWW.KNOWSLEYSK.COM

Due to continual product developments and improvements, Knowsley SK Limited reserve the right to change or modify the published performance characteristics without notice.